

FOOT MASTER

G-DOK IND.

FOOT MASTER

G-DOK IND.

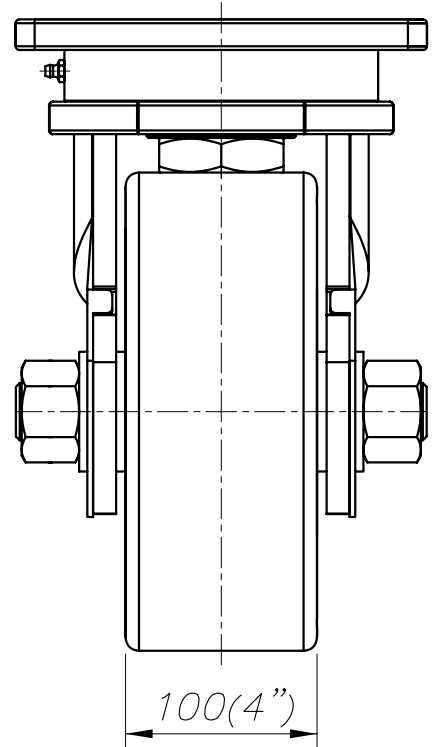
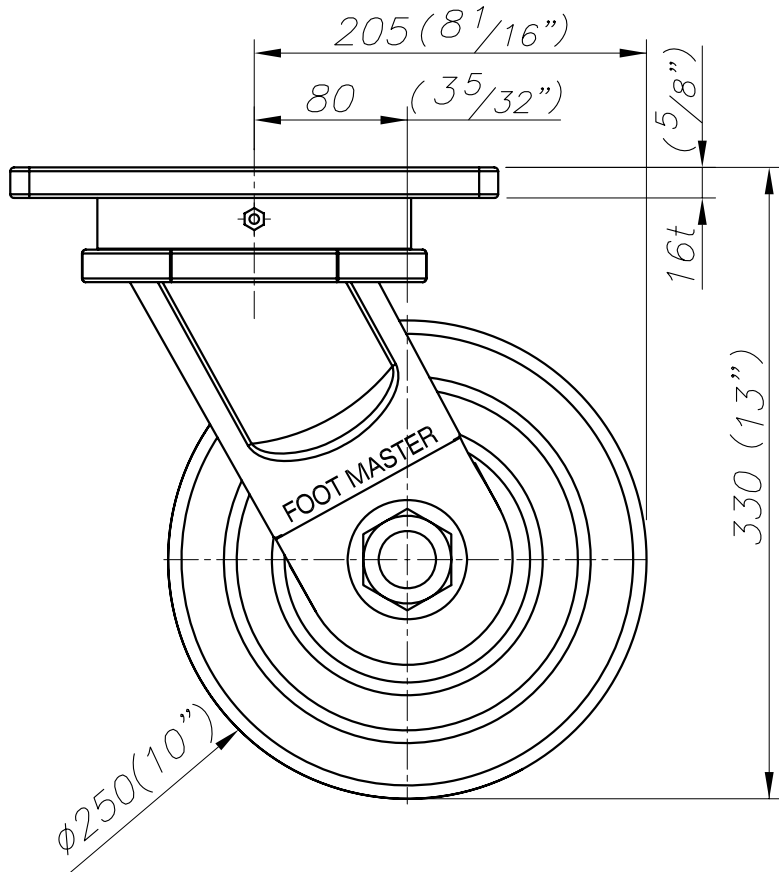
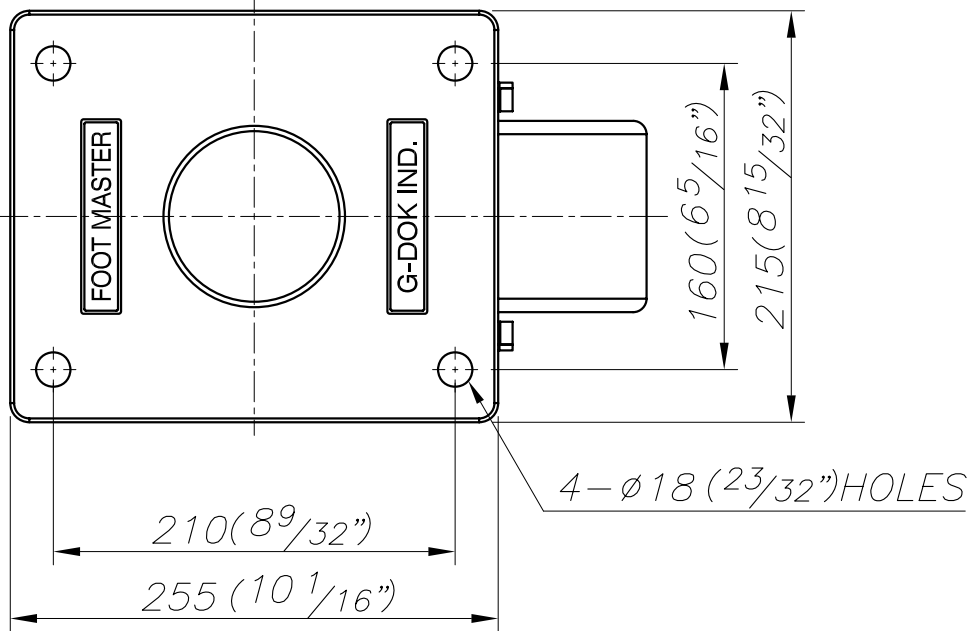

FOOT MASTER ®

FOOMA ®

G-DOK IND.

MODEL NAME

UGXT-250 SF

A

B

C

E

F

G

